



# User Guide of 1500W Small Size Continuous Wave Laser

Wuhan Raycus Fiber Laser Technologies Co., Ltd.

---

# TABLE OF CONTENTS

<b>1 Safety Information.....</b>	<b>1</b>
1.1 Security Identifiers.....	1
1.2 Laser Safety Grade.....	1
1.3 Security Identifiers.....	2
1.4 Optical Safety.....	3
1.5 Electrical Safety.....	3
1.6 Other Safety Rules.....	4
<b>2 Product Description.....</b>	<b>4</b>
2.1 Features.....	4
2.2 Model description.....	5
2.3 Package accessories.....	6
2.4 Unpacking and Inspections.....	6
2.5 Operation Environment.....	7
2.6 Attentions.....	8
2.7 Specifications.....	9
<b>3 Installation.....</b>	<b>11</b>
3.1 Dimensions.....	11
3.1.1 Overall dimensions of RFL-C1500 fiber laser.....	11
3.2 Size and installation of output optical cable.....	12
3.2.1 RFL-C1500 Output Optical Cable.....	12
3.3 Cooling system installation and requirements.....	13
3.4 Installation rules.....	15
<b>4 Using the Product.....</b>	<b>17</b>
4.1 Front panel.....	17
4.2 Rear Panel.....	17
4.3 Power Connection.....	19
4.4 Interface definition.....	19
4.4.1 Control interface.....	19
4.4.2 RS-232 serial port.....	21
4.4.3 Ethernet TCP / IP interface and connection steps.....	23
4.5 Installation Instruction.....	25
4.6 Start operation sequence.....	26
4.7 Control mode selection.....	27

4.7.1 Control mode wiring diagram.....	27
4.7.2 Stand-alone mode (internal control mode) (connect 4.6 in sequence).....	28
4.7.3 External control mode (sequentially connected to 4.6).....	29
4.7.4 AD Mode.....	30
4.7.5 controlling time-series chart.....	31
4.7.6 Red Light Control.....	32
4.8 Turning off the laser:.....	33
<b>5 Common Alarms and solutions.....</b>	<b>34</b>
5.1 Alarm display.....	34
5.2 Alarm processing.....	34
<b>6 Warranty, Return and Maintenance.....</b>	<b>38</b>
6.1 General Warranty.....	38
6.2 Limitations of Warranty.....	38
6.3 Service and Repair.....	39

## 1 Safety Information

Thank you for choosing Raycus fiber laser. This User Guide provides important safety, operation, maintenance and other information. Please read it carefully before using this product. In order to ensure safe operation and optimal performance of the product, please follow the warnings, cautions, operating procedures and other instructions accordingly.

### 1.1 Security Identifiers

	◆ <b>WARNING:</b> Describes a hazard that leads to a personal injury or death.
---	--

	◆ <b>CAUTION:</b> Describes a hazard that leads to a minor personal injury or product damage.
--	---

### 1.2 Laser Safety Grade

This series of lasers are classified as a high power Class 4 laser instrument accounting to the European community standards EN 60825-1, clause 9. This product emits invisible laser radiation at wavelength of 1080 nm, and the light power is 100-2000W (depending on the model). Under such high power of laser radiation, it may cause damages to the eyes or skin directly or indirectly. Despite the radiation being invisible, the beam may cause irreversible damages to the retina and cornea. Therefore, appropriate and approved laser goggles must be worn all the times when the fiber laser is operating.

	<p>◆ <b>WARNING:</b> Users must use appropriate laser goggles when operating this device. The laser goggles are selected according to the range of wavelength emitted from this product. Users must select the appropriate laser goggles according to the entire range of laser wavelengths. Please do not directly look at the fiber delivery cable connector when laser is powered on.</p>
---	--

### 1.3 Security Identifiers

Raycus CW Fiber Lasers have different locations of safety identifier depending on the model, as shown in Figure 1:

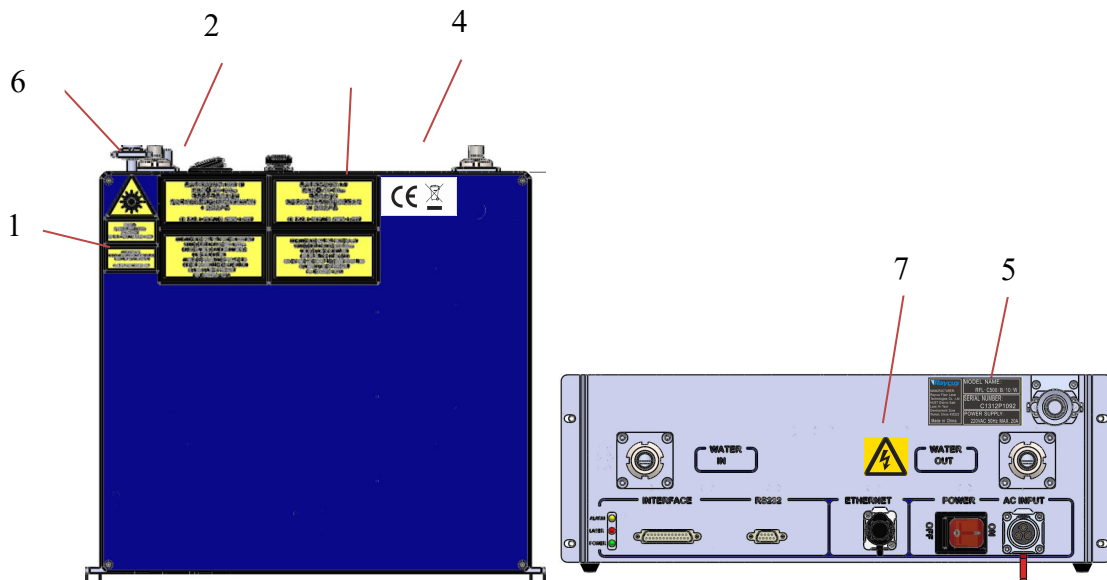

Figure 1 Laser Security Identifiers

Laser safety identifiers include: safety warning, laser output head warning, product certification, ID label, etc. The detailed descriptions of the security identifiers are as follows:

Table 1 Security Identifiers

1: Laser Output Head	2: Type 4 Laser Product	3: Class 2M Laser Product Label-1mW Red Laser
4: CE Authentication	5: ID Label	
6: Laser Radiation Hazard	7: Electrical Hazard	

## 1.4 Optical Safety

Any dust on the end of the collimator assembly can burn the lens.

	<p>◆ <b>CAUTION:</b> DO NOT emit laser when the protective cap is not removed, otherwise the lens or crystal will be damaged.</p>
--	---

## 1.5 Electrical Safety

1) Make sure the product is firmly grounded through the PE line of the AC power cord.

	<p>◆ <b>WARNING:</b> Any interruption from the protective earth will electrify the enclosure, which may result in personal injury for operators.</p>
--	--

2) Make sure that the correct voltage of the DC power source is used.



◆ **CAUTION:** Wrong wiring mode or power supply voltage will cause an irrecoverable damage to the laser device.

There are no devices that need to be used by operator in the laser. Please do not try to open the laser cover, otherwise it may cause electric shock and the warranty will be invalid accordingly.

## 1.6 Other Safety Rules

- 1) Do not directly look the laser fiber delivery cable connector when laser emitting.  
Avoid using the laser in a dark environment.
- 2) Do not use fiber lasers in dark environment.
- 3) If this device is used in a manner not specified in this document, the protection provided by the device may be impaired and the warranty will be voided.
- 4) There are no user serviceable parts, equipment or assemblies inside the product. All service and maintenance shall be performed by Raycus. In order to prevent electric shock, please do not break the seal or uncover the shield. Failure to comply with this instruction will void the warranty.

## 2 Product Description

### 2.1 Features

Raycus fiber laser, compared with traditional laser, has higher electro-optical conversion efficiency, lower power consumption and more excellent beam quality. It is compact and ready to use. Because of flexible laser output mode, it can be easy to integrate the device.

Main Features:

- Excellent beam quality
- High reliable and sealing
- High power stability
- Power continuously adjustable and fast switch response
- Maintenance-free operation
- High Electro-optical Conversion Efficiency
- Anti-reflection Capacity
- High modulation frequency and editable waveform

Applications:

- Welding、5G、Infrastructure
- 3D printing
- Laser research

## 2.2 Model description

Raycus continuous wave laser includes 100, 200L, 200, 300L, 300, 500, 750, 1000 and other models, which respectively represent 100W, 170W, 200W, 250W, 300W, 500W, 750W, 1000W and 1500W lasers. The definitions of the model code are shown in the table below:

Table 2 definition of model code

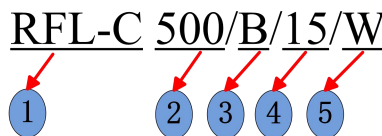
	
1	RFL-C series continuous wave laser



2	Power indicator, including 100, 200L, 200, 300L, 300, 500, 750, 1000, 1500W respectively representing 100W; 170W; 200W; 250W; 300W; 500W; 750W; 1000W; 1500 power laser
3	Wavelength, 'B' represents a wavelength of 1080nm
4	Output cable length, unit meter, including 15 meters and 20 meters, also can be customized length
5	Cooling method, 'W' stands for water cooling, 'A' stands for air cooling
Notes: RFL-C100 ~ RFL-C3000 laser without air conditioning	

### 2.3 Package accessories

Please refer to package accessories in the packing box.

### 2.4 Unpacking and Inspections

Raycus fiber laser is delivered with the specially designed package to offer the fiber laser maximal safety. Nevertheless, in order to prevent the occurrence of unpredictable circumstances during the transportation, please inspect all packaging once receiving the delivery. If you find any evidence of mishandling or damages, please keep the damaged material and contact the shipping agent and Raycus immediately.

Please double check if each listed content is included inside the package; and contact Raycus as soon as possible if there are any issue.

Take extra care when removing the unit from the package and make sure the fiber optic cable stay away from any possible collision and vibration. Please do NOT distort, bend or pull the output cable when unpacking the device; and avoid any collision to the fiber delivery cable connector.



◆ **CAUTION:** The fiber optic cable and fiber delivery cable connector are precise optic instrument, ANY vibration or impact to the fiber delivery cable connector, and twist or

	excessive bend to the cable will damage the instrument.
--	---

## 2.5 Operation Environment

The operation conditions are listed as the following table:

Table 3: The Operation Environment Conditions for the Laser

Model	RFL-C1500/C1500H
Power Voltage(V)	220±10% V AC 50/60Hz
Power Capacity (kW)	5.5
Installation Environment	Flat and no vibration
Ambient Temperature (°C)	10~40
Relative Humidity (%)	<70

### Warning:

- 1) Make sure the product is properly grounded before use.
- 2) The laser output head is connected with fiber optic cable. Please inspect the output head carefully to prevent dust or other contaminations. Use appropriate lens paper to clean it if necessary.
- 3) Failure to follow the instructions when operating the laser may cause malfunction and damage.
- 4) It is not allowed to install the output head when the laser is in operation.

- 5) Do not look into the output head directly. Wear appropriate protective eye glasses all the time when operating the laser

	<ul style="list-style-type: none"> <li>◆ Do not expose this product to high humidity (humidity &gt; 95%).</li> <li>◆ Do not allow this product to operate at a temperature below the ambient dew point. (As shown in Table 4)</li> </ul>
---	--

Table 4 Comparison table of constant dew point at ambient temperature and relative humidity

Constant dew point table at ambient temperature and relative humidity									
Ambient temperature (°C)	Maximum relative humidity								
	20%	30%	40%	50%	60%	70%	80%	90%	95%
20	-3.5	2	6	9	12	14.5	16.5	18	19
25	0.5	6	10.5	14	16.5	19	21	23	24
30	4.6	10.5	15	18.5	21.5	24	26	28	29
35	8.5	15	19.5	23	26	28.5	31	33	34
40	13	20	24	27.5	31	33.5	36	38	39
Laser operating temperature range									

## 2.6 Attentions

- 1) Make sure that the correct voltage (according to Table 3) is used before connecting AC current. Failure to connect power supply will damage the device.
- 2) Failure to operate the laser in accordance with the control or adjustment methods specified in this manual may cause damage.

- 3) For the output laser collimated by the collimating lens, it is important to keep the collimating lens clean, otherwise it will damage the device.
- 4) Please cap the output head when it is not in use. Do not touch the output lens at any time. Use appropriate lens paper and alcohol to clean it if necessary.
- 5) Failure to follow the instructions may cause laser power loss, and such loss is not covered by warranty.

## 2.7 Specifications

Table 5 Product Specifications

Model	RFL-C1500	RFL-C1500H	Test Conditions
<b>Optical Characteristics</b>			
Output Power(W)	1500		
Operation Mode	CW/Modulated		
Polarization State	Random		
Power Range(%)	10~100		
Central Wavelength (nm)	1080±5		Nominal Output Power
Output Power Instability (%)	±1.5		Nominal Output Power; Duration: ≥5hrs; Ambient Temp.: 25±1°C
Modulation Frequency(Hz)	1~20,000		Nominal Output Power
Red Laser output Power(mW)	0.1~1		
<b>Optical Output Characteristics of QBH head</b>			
Beam quality M <sup>2</sup>	5~6	/	
Beam Parameter Product (BPP)	/	BPP<1.5(mm*rad)	Nominal Output Power 4δStandard
Half Angle Divergence (rad)	/	≤0.06	
Core Fiber(μm)	50 (20、25、100、200 are optional)		
Delivery Cable (m)	20	10	Customizable length
<b>Electrical Characteristics</b>			
Power Supply	220±10% V AC、50/60Hz		
Max. Power Consumption(W)	5500		
Control Mode	RS-232/AD/Ethernet		
<b>Other Characteristics</b>			
Dimensions(W×H×D) (mm)	410×610×150(include handle)		
Weight(kg)	<40		
Operating Ambient Temperature (°C)	10~40		
Humidity(%)	<70		
Storage Temperature(°C)	-10~60		
Cooling Method	Water Cooling		

### 3 Installation

#### 3.1 Dimensions

##### 3.1.1 Overall dimensions of RFL-C1500 fiber laser

Figure 2 shows the external dimensions of the RFL-C1500 laser.

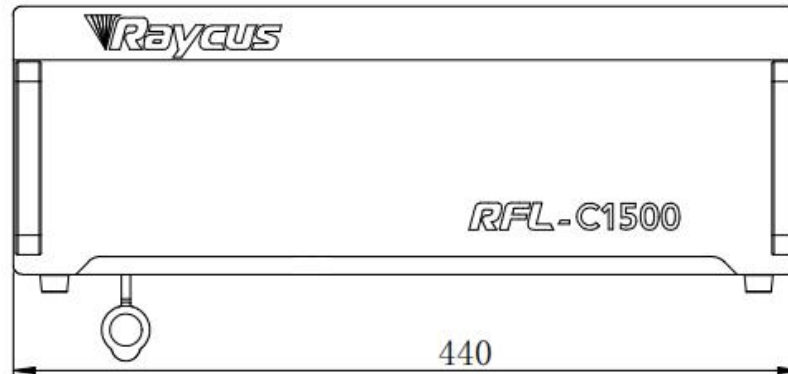

Figure 2 (a) Front view (Unit: mm)

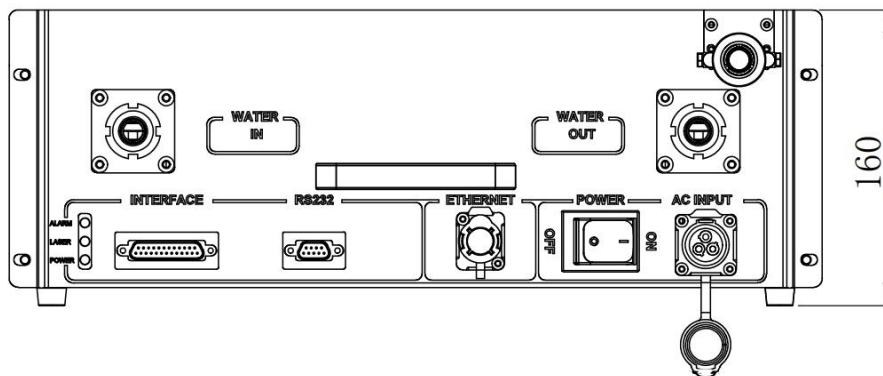

Figure 2 (b) Rear view (unit: mm)

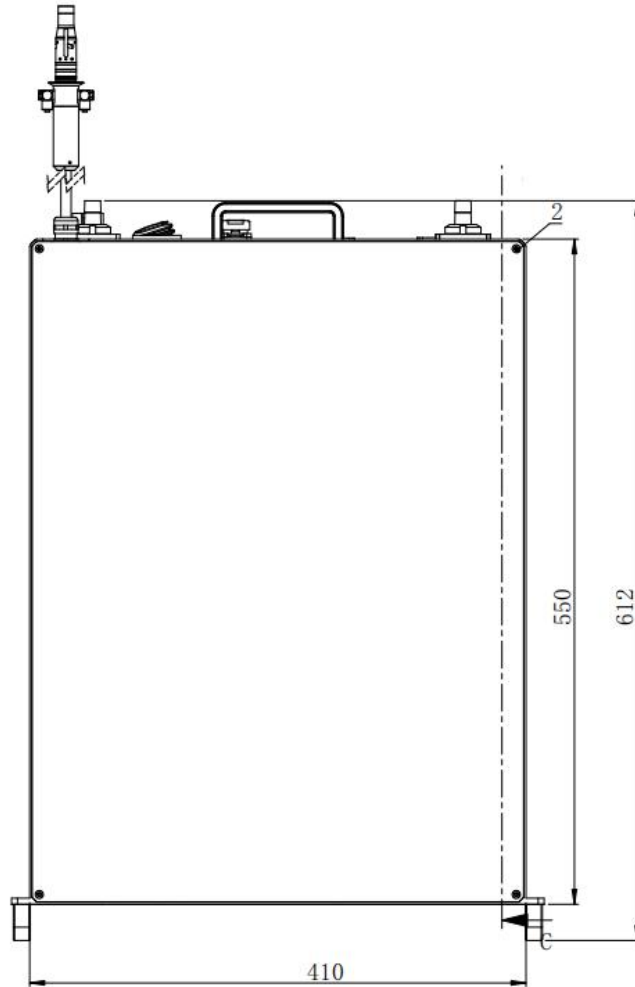

Figure 2 (c) Top view (Unit: mm)

Note: 1500W laser uses dimension 610 to substitute dimension 446 in the chart

### 3.2 Size and installation of output optical cable

Raycus continuous wave fiber laser uses different laser output cables according to different laser models.

#### 3.2.1 RFL-C1500 Output Optical Cable

The output cables of Raycus RFL-C1500 fiber lasers are self-made IQB output cables. The specific appearance dimensions are shown in Figure 4 below:

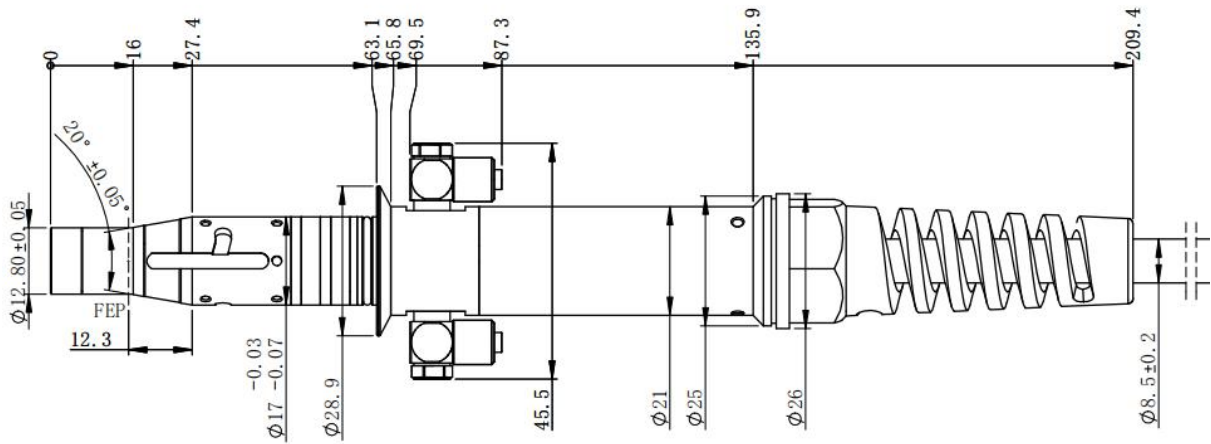

Figure 4 Dimensional drawing of welding IQB output optical cable

	<ul style="list-style-type: none"> <li>◆ For IQB output optical cables, the two copper contacts (InterLock pins) on the output head must be shorted before the laser works, otherwise the laser will not work properly. Usually the copper contacts are automatically shorted after the output fiber cable is installed in the processing equipment.</li> <li>◆ Before installing the output cable in the processing head, the lens of the output cable must be inspected. If the lens is dirty, it must be cleaned.</li> <li>◆ It is forbidden to disassemble the output lens by anyone other than Raycus, otherwise the warranty will be invalid.</li> </ul>
--	--

### 3.3 Cooling system installation and requirements

Table 6 Cooling System Requirements

Model	1500
Cooling Capability (W)	>4500
Minimum Flow (L/min)	20
Maximum Pressure (Bar)	7
External diameter of pipe (mm)	13
Cooling system water temperature (°C)	$25 \pm 1^\circ\text{C}$



1) Temperature setting of cooling water:

- $25\pm 1^{\circ}\text{C}$  (does not need to change in summer)

2) Requirements on Cooling Water:

- Purified water should be used.
- In order to prevent the growth of mold that may lead to blockage, adding alcohol solution to about 10% of the total volume is recommended.
- If ambient temperature is between  $-10^{\circ}\text{C}$  and  $0^{\circ}\text{C}$ , we recommend to use 30% alcohol(volume ratio), and replace it every 2 months.
- If ambient temperature is below  $-10^{\circ}\text{C}$ , the chiller with both heating and cooling functions must be used, and keep it in full-time operation.

3) Other cooling system requirements:

- Check the entire water system and joints for leaks when starting the cooling system the first time. The external water pipe must be installed and connected according to the water inlet (IN) and water outlet (OUT) indicated according to the laser, otherwise the laser may not work properly.
- If the laser is not used for a long time, the cooling system and the cooling water inside the laser should be drained, otherwise it will cause irrecoverable damage to the laser.

	<p>◆ Set the water temperature of the cooling system correctly according to the ambient temperature. If the water temperature is set too high, the laser will not work properly. If the water temperature is set too low, condensation will occur inside the laser or the laser output cable, which will cause irrecoverable damage to the laser.</p>
---	---

	<p>◆ Before starting the laser, the cooling system must work properly and the water temperature reaches a suitable temperature.</p>
---	---

### 3.4 Installation rules

- 1) Place the product in an appropriate position, immobilize it if necessary.
- 2) Check if the power supply has the correct voltage (laser model and power voltage refers to product parameters in Table 5 ), and the earth line is connected, and ensure the earth line is firmly connected.
- 3) Connect the power cable and control cable to the product when power supply is OFF.
- 4) Connect the cooling system to the laser and output fiber cables according to the water inlet and outlet signs.
- 5) Please check the laser output head and do the necessary cleaning before installing it in the device. If you find that there is dust or foreign objects that cannot be cleaned, please contact Raycus in time, and do not continue installation and operation for the time being.
- 6) Prevent the delivery cable from treading, pinching or excessive bending during installation.

- 7) Please handle the laser output cable carefully, and do not receive vibration during the installation and disassemble.
- 8) Make sure the environment is clean, or the output head may be contaminated. It is prohibited to use fan during installation, which will cause dust in the air.
- 9) The minimum bending radius of the transmission cable of the laser shall not be less than 20cm in the non-working state (such as transport and storage). The minimum bending radius should not be less than 30cm when the laser is working.

	<ul style="list-style-type: none"><li>◆ CAUTION: All the cables can only be connected when power supply is off. Hot plug may damage the device.</li></ul>
---	---

	<ul style="list-style-type: none"><li>◆ Ensure that there are no fiber bends in radius less than 30cm when the product is installed. Avoid excessive twisting and tight bends during the robotic arm movements.</li><li>◆ Tight bends will damage the laser delivery system.</li></ul>
---	--

	<ul style="list-style-type: none"><li>◆ Before the laser output cable is assembled, the lens and the output head cavity must be clean and free of pollution.</li><li>◆ Keep the protective cap properly, prevent it from contamination; Or the aperture will be contaminated when capped.</li></ul>
---	---

## 4 Using the Product



**The Raycus continuous wave laser (with network port) has stopped using the super terminal. After the laser is powered on, there is no display on the super terminal. Please log in to the official website of Raycus to download the new version of the upper computer software and upper computer software instruction manual.**

**Web: <http://www.raycuslaser.com/index.php/index-show-tid-53.html>**

---

---

### 4.1 Front panel

Figure 5 shows the front panel style of RFL-C1000 ~ RFL-C1500 welding laser (taking RFL-C1000 as an example, the front panel styles of other products are the same):



Figure 5 RFL-C1000 laser front panel

### 4.2 Rear Panel

Figure 6 shows the rear panel style of the RFL1500 laser.

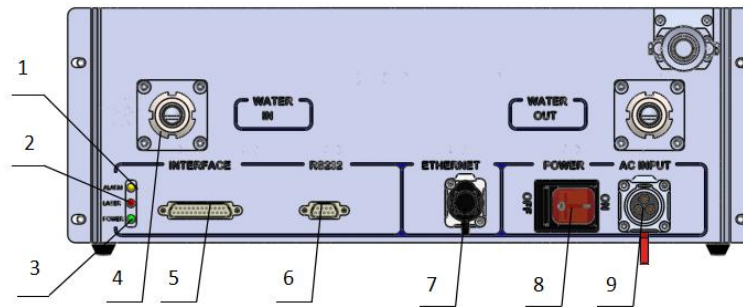

Figure 6 RFL-C1500 laser rear panel

1. **Alarm:** Laser fault indicator
2. **Laser:** Laser output indicator
3. **Power:** Power Indicator, indicates that the power is switched on when the LED illumines.
4. **Water pipe joint:** Pagoda joint, insert the quick-plug water pipe with an outer diameter of 16 into the pagoda head and fasten it with a clamp to connect the laser to the circulating cooling water.
5. **Interface:** Laser external control interface, see [4.4 Interface and Definition]
6. **RS232 :** 232 serial interface for communication between laser and host computer.
7. **ETHERNET:** Ethernet interface for communication between laser and upper computer.
8. **Power:** Rocker switch for turning on the laser's main power.
9. **AC INPUT:** 220V Power line input

### 4.3 Power Connection



	<p>◆ Before connecting the AC power supply, please check whether the laser model and the AC power supply provided are consistent with those listed in Table 3 or table 5.</p>
---	---

Table 7 Power connection requirements

Model	RFL-C1500
Power supply	<p>220±10% V AC</p> <p>50/60Hz</p>
Power cord	
Power cord end	Three strands, marked L, N and PE respectively
Label description	<p>L-&gt;Phase line (brown)</p> <p>N -&gt;Neutral (blue)</p> <p>PE-&gt;Protective earth wire (yellow green)</p>
Note	Insert the plug at the end of the power cord into the socket marked "AC INPUT" on the rear panel. Note that the plug has anti-reverse connection function. After plugging it in, lock it with a lock.

### 4.4 Interface definition

#### 4.4.1 Control interface

Figure 7 shows the DB25 control interface diagram:

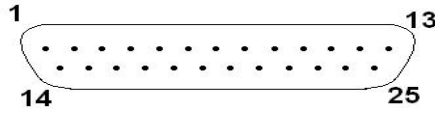

Figure 7 DB25 control interface

The pin definitions of DB25 are as follows:

Table 8 Control interface definition

PIN	NAME	Input and output	Function	Typical	Min	MAX	Electric current
2	Reserve interlock	/		Short circuit			
3	Reserve interlock						
8	Reserve long-distance power supply			Short circuit			
9	Reserve long-distance power supply						
10	Reserve emergency stop			Short circuit			
11	Reserve emergency stop						
12	Analog	Analog input	External analog quantity setting	0-10V	0V (0%)	10V (100%)	<10mA
13	Laser Power	Analog output	Optical power signal output		0V (0%)	3.3V (100%)	<10mA
14	AGND	Analog ground	12, 13 pin return	0V			
15	MOD+	Digital input	Laser modulation signal	5-24V	5V	24V	<10mA
16	MOD-	Return port	15 pin return	0V			

17	Red Laser	Digital input	Red light control		5-24V	5V	24V	<10mA
18	Laser EN	Digital input	Laser enable		5-24V	5V	24V	<10mA
19	Ready	Digital output	Laser ready		EVCC			<100mA
20	EGND	Digital ground	17, 18, 21 pin return		0V			
21	EX_RST	Digital input	Laser fault reset		5-24V	5V	24V	<10mA
22	Laser Error	Digital output	Laser fault output signal		EVCC			<100mA
23	EVCC	Digital input	External voltage for output of Ready and Error signals		5-24V	5V	24V	<100mA
other	NC		Not allowed to connect					

	<ul style="list-style-type: none"> <li>◆ Please check the level of the control signal to ensure compliance. Exceeding voltage or voltage fluctuations may damage the laser.</li> <li>◆ Please ensure that the analog signal DOES NOT exceed 10V, or product may be damaged.</li> <li>◆ Please use 2 and 3, 8 and 9, 10 and 11 through short circuit.</li> </ul>
--	---

#### 4.4.2 RS-232 serial port

The following figure shows the RS-232 serial port

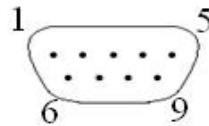

Figure 8 RS232 serial port

Each pin is defined as follows.

Table 9 RS-232 serial port definition



Model	Definition
2	RX
3	TX
5	GND
others	None

A three-core (RxD, TxD, GND) interface is used. For specific commands and descriptions, please refer to the software manual of the host computer or ask a Raycus technician for a communication protocol. The specific parameter settings of the RS-232 control interface are as follows:

Table 10 RS-232 interface configuration parameters

Parameters	Set up
Baud rate	9,600
Data bits	8
Stop bit	1
polarity	None
Flow control	None

Figure 9 RS-232 serial cable configured for the product



Figure 9 RS-232 serial cable

### 4.4.3 Ethernet TCP / IP interface and connection steps

The default IP address of the laser is 192.168.0.10 and the laser only supports UDP communication. The laser listens for connections on port 8099. The command must be sent as a single string in a single packet.

Table 11 Ethernet interface pin definition

PIN	Feature	Description
1	TX+	Transmit Data+
2	TX-	Transmit Data-
3	RX+	Receive Data+
4	N/C	Not Connected
5	N/C	Not Connected
6	RX-	Receive Data -
7	N/C	Not Connected
8	N/C	Not Connected

If conditions permit, please use this interface first to get better communication stability.

#### **Ethernet connection steps:**

First Step: Open Raycus PC software, click "Session → RS232(or Ethernet)" to make the host computer communicate with the laser, and then click "Tool → Laser IP Set" to enter the laser IP address setting;

Second Step: The default password is "1122334455667788". After passing the verification, read or set a new laser IP address.

Third Step: If you use the upper computer software of Raycus to control the laser, you need to find the folder where the upper computer software is located,

open the laser configuration file config.xml, and write the newly set IP address of the laser; if you do not use the upper computer of Raycus, please directly enter the fourth step;

Fourth Step: Configure the Ethernet network connection on the PC side, select "Use the following IP address:", and manually assign the IP address. The PC side IP address must be on the same network segment as the laser IP address, and assign a subnet mask address. The default is 255.255.255.0. Click the "OK" button to confirm the settings and exit.

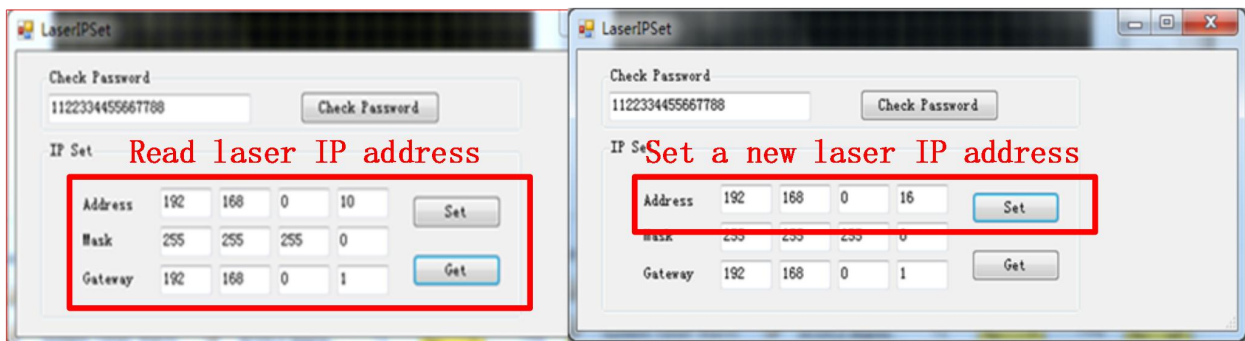

Skip this step if you do not control the laser with a Raycus host computer

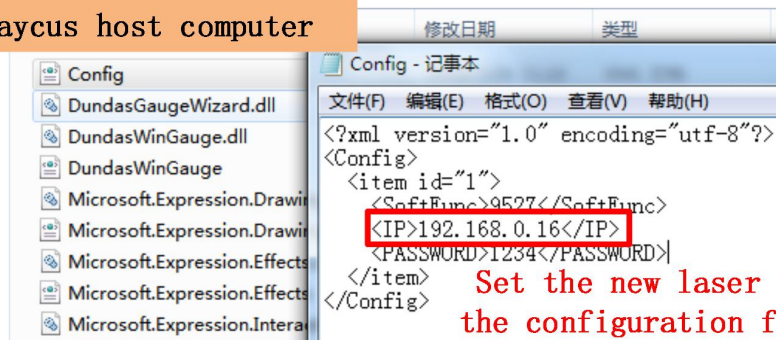

Set the new laser IP address in the configuration file config.xml

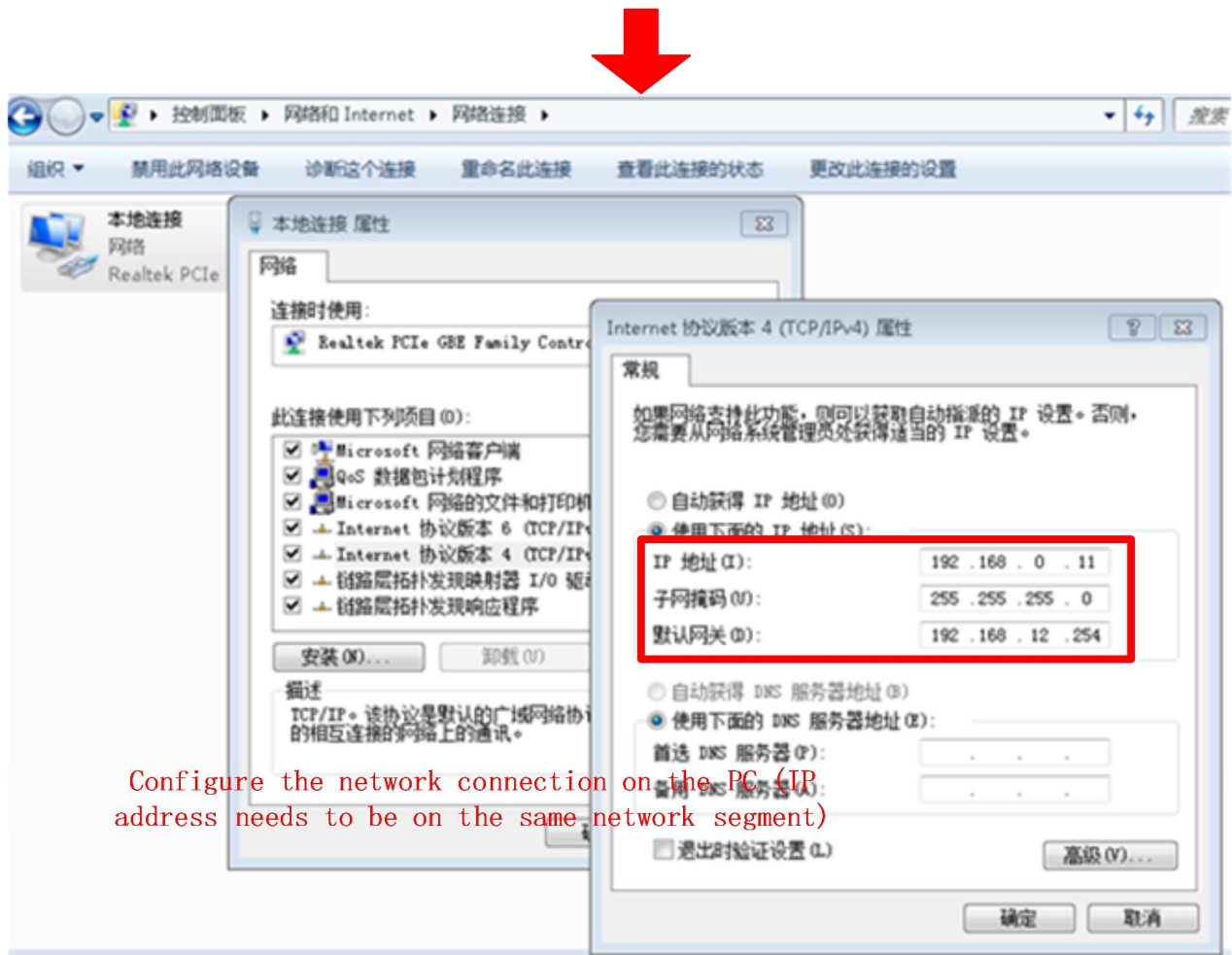

Figure 10 Ethernet connection steps

#### 4.5 Installation Instruction

- 1) Take out the laser carefully, move it to the installation position, remove the handle, and use the handle to install the hole position to fix it with screws.
- 2) Remove the protection cap of the output head, use strong light to check if there is dust on the lens of the output end. If so, please clean it before use, and then cover the protection cap of the output head.
- 3) Install the output optical cable on the processing equipment according to the actual situation (also install the output head cooling water pipe), pay

attention to arrange the output optical cable, and protect the output head.

After installing and arranging the output optical cable, remove the protective cap, and check whether the output lens is clean again, and then install the output head;

- 4) Connect the laser cooling water pipe;
- 5) Connect the control line and power supply according to the control mode.

#### **4.6 Start operation sequence**

Make sure the rocker switch is off. All electrical connections must be completed before the laser is powered on.

- 1) Turn on the chiller and check the water pipe for leaks. If there is no leakage, turn off the chiller and wait for the laser to turn on.
- 2) Close the rocker switch on the rear panel and wait for the laser to power on and perform a self-test.

Note: When the working environment temperature and relative humidity are within the dew point area (blue) in Table 4, for RFL-C100 to C3000 type lasers, please improve the working environment of the laser to avoid damage to the laser due to condensation.

## 4.7 Control mode selection

### 4.7.1 Control mode wiring diagram

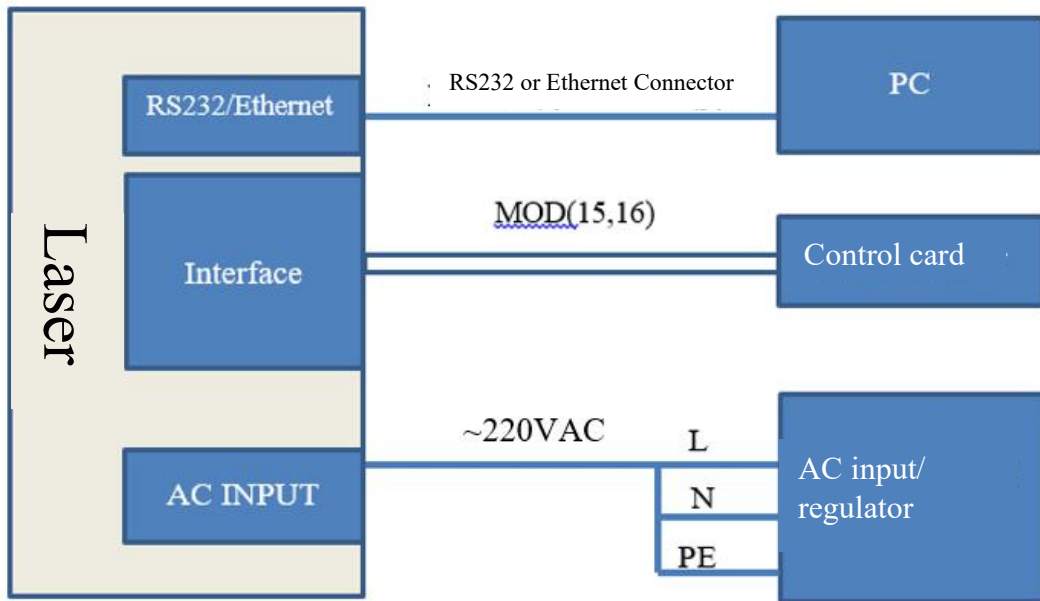

Figure 11 Wiring diagram in RS-232 mode

Note: In the above mode, the upper computer of Raycus should be used to modify the mode: turn off the external red light control, external light out enable and external AD, and only keep the modulation mode.

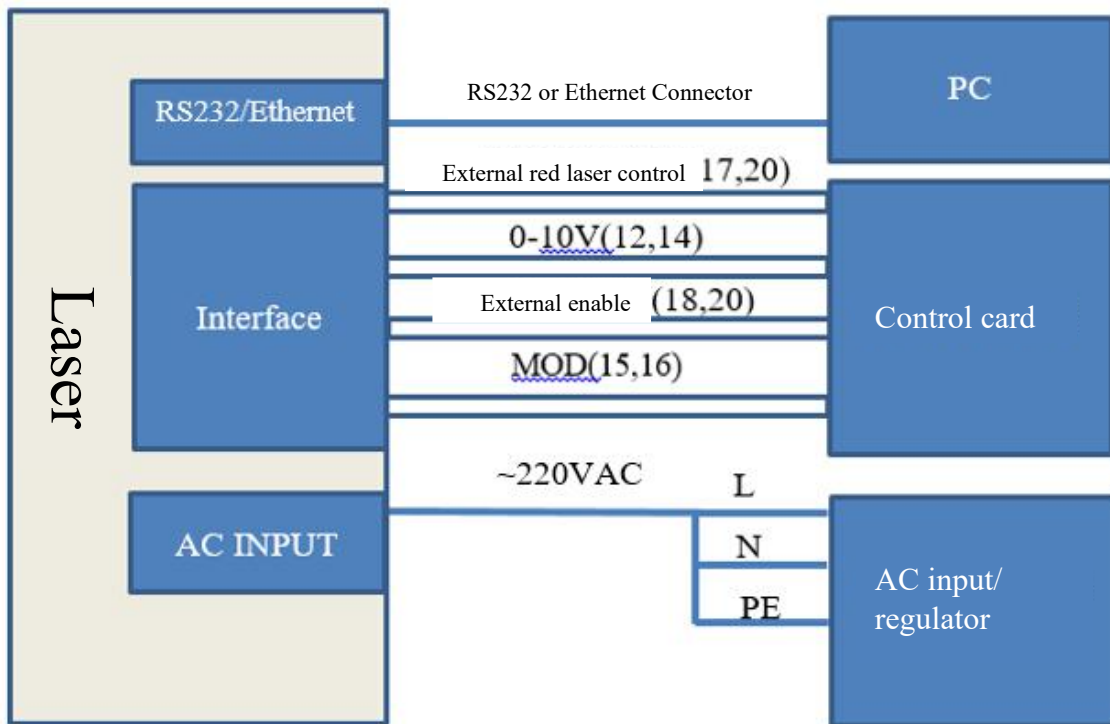

Figure 12 Wiring diagram in AD mode

#### 4.7.2 Stand-alone mode (internal control mode) (connect 4.6 in sequence)

- 1) Turn on the rocker switch, and the panel "power" indicator light is on
- 2) Wait for 20s, internal main control board circuit initialization is completed.
- 3) Turn off all external control mode of the laser (turn off external control of red laser, external light emitting enable, external AD and modulation mode )
- 4) Set the power of the laser (the laser power is to be set by 0-10V analog quantity, when the AD mode is on; and to be set by the serial port or Ethernet, when the AD mode is off).
- 5) Turn on the laser enable

- 6) The serial port or the Ethernet interface sends a shutter opening command to output the laser, and sends a shutter closing command to turn off the laser.

Shutdown the laser, please refer to 4.8

### 4.7.3 External control mode (sequentially connected to 4.6)

**Modulation:** When the duty cycle of the laser's internal frequency is set to 100%, the laser works in external modulation mode. The on and off of the laser is controlled by the "modulation" signal provided by the user from the external MOD interface. For the timing diagram, see [4.7.5 Control timing Figure];

**Gate mode:** When the duty cycle of the laser's internal frequency is set to less than 100%, the laser works in internal modulation mode. The laser is turned on and off by the user from the external MOD signal and internal frequency generator. Stop internal pulse generation, see [4.7.5 Control Timing Diagram] for timing diagram;

The laser works in external modulation mode by default after power on.

- 5) Turn on the rocker switch, and the panel "power" indicator light is on
- 6) Wait for 20s, internal main control board circuit initialization is completed



- 7) Set laser power (laser power is set by 0-10V analog when AD mode is enabled, laser power is set by serial port or Ethernet when AD mode is off)
- 8) Send a light enable signal to the laser in one of the following ways
  - Interface gives light enabling signal (connect 24V between pin18 and pin20)
  - serial port or Ethernet interface to issue the shutter open command-enable light
- 9) The On/Off of the laser is controlled by the "modulation" signal provided by the external mod interface;

Shutdown the laser, please refer to 4.8

#### **4.7.4 AD Mode**

The laser enters the external AD mode through the upper computer selection. The laser power is controlled by the voltage between pin12-14 of DB25 control interface (0v-0% power, 10v-100% power).

If the upper computer selects external AD mode off, the laser power is set by serial port or Ethernet, and the Raycus hand-heldwelding laser will enter external ad mode by default when powered on.

### 4.7.5 controlling time-series chart

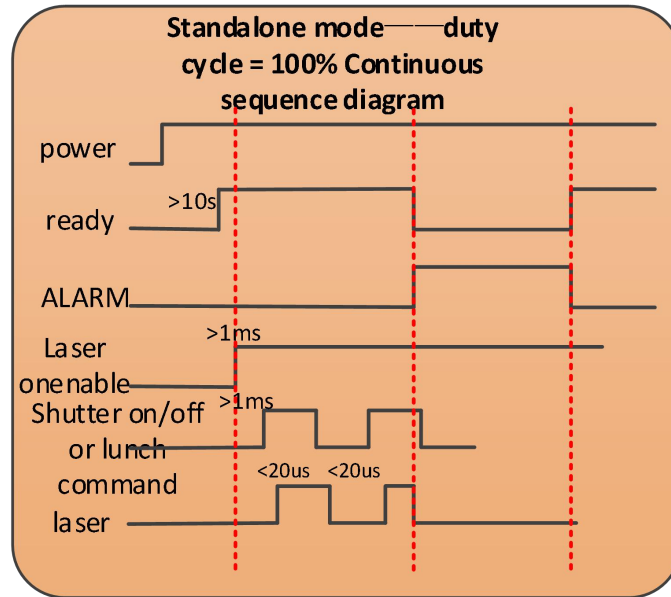

Figure 13 Standalone mode—Continuous sequence diagram

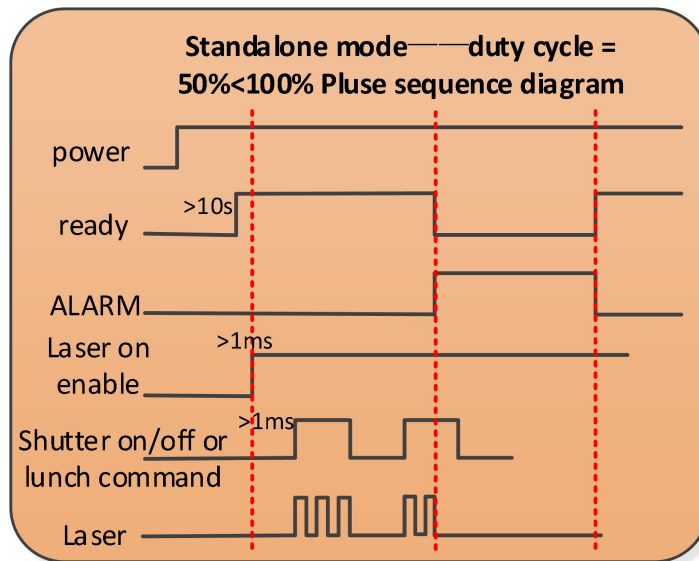

Figure 14 Standalone mode – Pluse sequence diagram

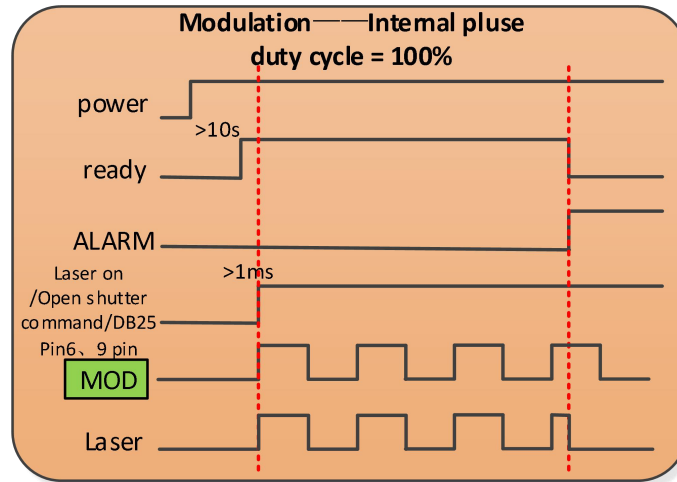

Figure 15 Modulation—sequence diagram

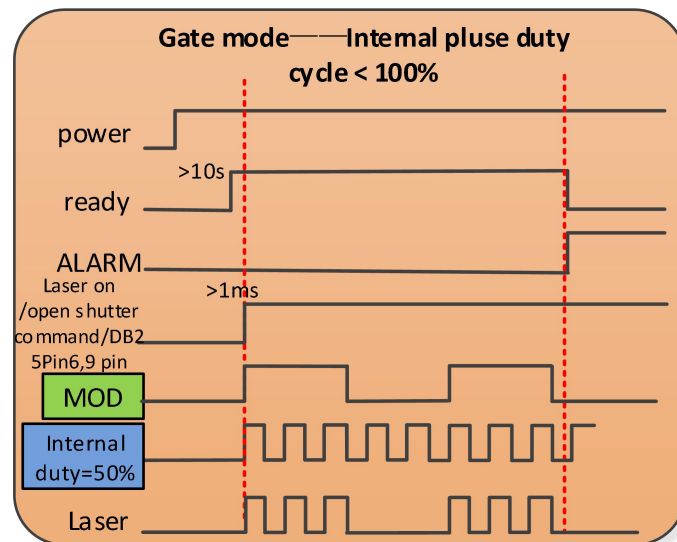

Figure 16 Gate mode –sequence diagram

#### 4.7.6 Red Light Control

Turn on the rocker switch, the green "POWER" indicator light is on, wait for 20s, the laser enters the red-light external control mode, and a high level of 5-24V is given before the 17-20 pin. If red light internal control is selected on the host computer, you can use the host computer to click "red light on" to turn on the red light.



◆ **Laser and red indicator light can be output simultaneously**

#### **4.8 Turning off the laser:**

Please turn off the laser in the following sequence

- 1) Turn off the laser output enable
- 2) Turn off the rocker switch
- 3) Turn off the chiller
- 4) If the laser is not equipped with air conditioner, please ignore this step; If it is equipped, please wait for the air conditioner to continue working for 10min;
- 5) Put on the output head protection cap

## 5 Common Alarms and solutions

### 5.1 Alarm display

Connect the computer and open the PC software (download the PC software and its instruction manual, please log on the Raycus official website), after the laser and client software establish normal communication. All laser alarm states can be displayed on the client software interface, as shown in Figure 17. The laser will give an alarm in the case of abnormal internal temperature, abnormal output power, abnormal power supply, abnormal condensation, etc.

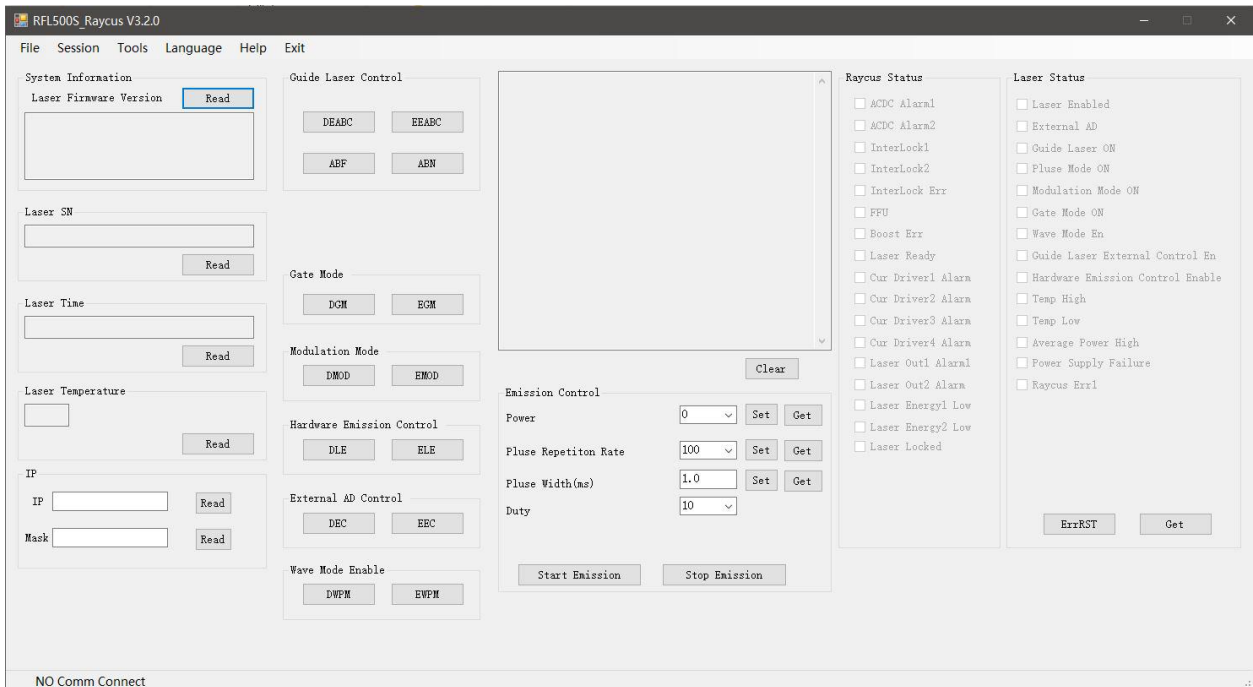

Figure 17 main interface of upper computer software

When the laser is working and any alarm occurs (except for the abnormal interlock), the upper computer software interface will also display the alarm. At the same time, the alarm light (yellow) on the laser panel will be on, and the laser will stop and lock.

### 5.2 Alarm processing

The instructions and possible solutions of alarms are as follows:

Table12 Error instructions and possible solutions

Alarm message	Error instructions and possible solutions
System Timer Alarm	<p><b>Instruction:</b> Internal clock abnormal</p> <p><b>Solutions:</b> When this alarm occurs, please contact Raycus directly</p>
Laser On Button Alarm	<p><b>Instruction:</b> This alarm occurs when the light exit button on the front panel of the laser has been pressed before powering on</p> <p><b>Solutions:</b> When this alarm occurs, please power off the laser and make the light enable button pop up, and then power on the laser again to cancel the alarm. If the alarm continues to occur, please contact Raycus.</p>
Inter Lock Alarm	<p><b>Instruction:</b> Occurs when the laser InterLock is disconnected</p> <p><b>Solutions:</b> Short the InterLock pins. If this error continues to occur, please contact Raycus.</p>
Current Driver Alarm	<p><b>Instruction:</b> Internal constant current driver is error</p> <p><b>Solutions:</b> Restart the Device. If this error continues to occur, please contact Raycus.</p>

Laser OutAlarm	<p><b>Instruction:</b></p> <p>The laser will get this alarm when it can not detect any laser light signal. Laser out alarm occurs only when the laser is emitting light</p> <p><b>Solutions:</b></p> <p>Restart the Device. If this error continues to occur, please contact Raycus.</p>
Laser Power Alarm	<p><b>Instruction:</b></p> <p>The alarm is generated when the emission of the laser cannot reach the set value. Power alarm occurs only when the laser is emitting light.</p> <p><b>Solutions:</b></p> <p>Restart the Device. If this error continues to occur, please contact Raycus.</p>
ACDC1 Alarm	<p><b>Instruction:</b></p> <p>AC/DC1 Alarm. Laser power supply out of work or sudden power disconnect of the power supply system may cause the alarm</p> <p><b>Solutions:</b></p> <p>Check whether the input AC voltage is normal. Restart the laser to try when it is normal. If the alarm continues to occur, please contact Raycus.</p>
ACDC2 Alarm	<p><b>Instruction:</b></p> <p>AC/DC2 Alarm. Overcurrent or overvoltage inside the device may cause this error.</p> <p><b>Solutions:</b></p> <p>Check whether the input AC voltage is normal. Restart the laser to try when it is normal. If the alarm continues to occur, please contact Raycus.</p>

<p>T1/T2 Alarm</p>	<p><b>Instruction:</b></p> <p>Laser low / high temperature alarm occurs when the sensor in the laser detects that the internal temperature of the laser is abnormal. A high-temperature / low-temperature error occurs when the temperature at the monitoring point exceeds the set upper / lower limit.</p> <p><b>Solutions:</b></p> <p>High temperature alarm.</p> <p>Check whether the water-cooling system is normally working, the water temperature is set correctly, and also the water connection is correct. When the water cooling system works normally and the water temperature drops below 30°C, restart the laser. If the alarm continues, please contact Raycus.</p> <p>Low temperature alarm.</p> <p>Check whether the actual water temperature of the water is too low. In addition, a low ambient temperature may also cause a low temperature alarm when the laser is cold. Please wait until the water temperature of the water rises above 10°C and then restate the device. If the alarm continues, please contact Raycus.</p>
<p>Hum Alarm</p>	<p><b>Instruction:</b></p> <p>The laser detects that the current temperature of the water-cooled plate is lower than the current dew point temperature of the laser. There is a risk of condensation.</p> <p><b>Solutions:</b></p> <p>Stop using the laser immediately. For RFL-C100 ~ RFL-C1000 lasers, please improve the working environment so that the ambient temperature is lower than the internal temperature, and then restart the laser (recommended to configure a separate air-conditioned room for the laser). For the RFL-C1500S / C2000S laser, please wait 30 minutes for the air conditioner to run, and then restart the laser. If the alarm continues, please contact Raycus.</p>



In addition to the above, if there are any other questions or errors, please contact Raycus to get help.

## **6 Warranty, Return and Maintenance**

### **6.1 General Warranty**

Raycus warrants that all Raycus fiber laser products are conformed to applicable product specifications under normal use and are free from defects in materials and workmanship.

The warranties start on the date of shipment from Raycus for a period of time as set forth in the applicable purchase contracts or product specifications. Raycus has the right to choose to repair or replace any product that proves to be defective in materials and workmanship selectively during the warranty period. Only products with particular defects are under warranty. Raycus reserves the right to issue a credit note for any defective products produced in normal conditions.

### **6.2 Limitations of Warranty**

The warranty does not cover the maintenance or reimbursement of our product of which the problem results from tampering, disassembling, misuse, accident, modification, unsuitable physical or operating environment, improper maintenance, damages due to excessive use or not following the instructions caused by those who are not from Raycus. The customer has the responsibility to understand and follow this instruction to use the device. Any damage caused by fault operating is not warranted. Accessories and fiber connectors are excluded from this warranty.

According to the warranty, client should write to us within 31 days after the defect is discovered. This warranty does not involve any other party, including specified buyer, end-user or customer and any parts, equipment or other products produced by other companies.



◆ **WARNING:** It is the customer's responsibility to understand and follow operating instructions in this User Guide and specifications prior to operation-failure to do so may void this warranty. Accessories and fiber connectors are not covered by this warranty.

### 6.3 Service and Repair

- Do not open the device. There are no user serviceable parts, equipment or assemblies for user in this product. All service and maintenance shall be performed by qualified Raycus personnel.
- Please contact Raycus as soon as possible when problems under warranty about maintenance happened to the product.
- The product returned with permission should be placed in a suitable container.
- If any damage happened to the product, please notify the carrier in document immediately.

**We reserve the right to make changes in design or constructions of any of our products at any time without incurring any obligation to make changes or install the same on units previously purchased.**

**All the items about warranty and service above provided by Raycus are for uses' reference; formal contents about warranty and service are subject to the contract.**

---

© 2019 Wuhan Raycus Fiber Laser technologies Co. Ltd, All Rights Reserved